

Play



nicoline

Descrizione modello - *Model Description*

Dimensioni - *Dimensions*

Composizioni consigliate - *Recommended compositions*

nicoline.it

ITALY - C.da Parchi Calia sn Z.I. - 70022 Altamura – BA - Telefono: +39 080 3101487

UNITED STATES - Nicoline Salotti Inc. po box 38783 - Greensboro – NC 27438 - Phone: +1 (336) 259 9881

SINGAPORE - 23 Genting Road #06-01 - Chevalier House Singapore 349481 - Telefono: +65 8168 3354

PLAY

Design Application N° 008642821-0016



frontale // front



laterale // depth

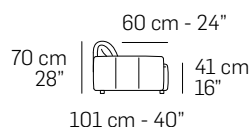

parete // wall

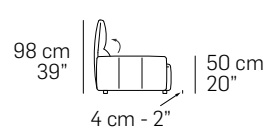
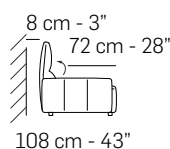

frontale B (Big) // front B (Big)



laterale // depth

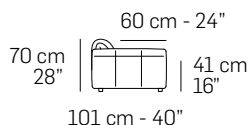

parete // wall

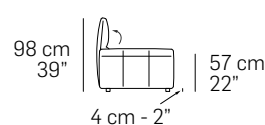
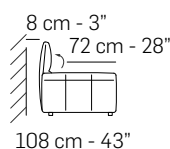

Caratteristiche standard

- Struttura in multistrato e massello di abete con rinforzi in metallo, molleggio seduta con cinghie elastiche.
- Imbottiture in poliuretano espanso ecologico a cellula aperta con densità differenziate.
- Rivestimento in pelle o tessuto. Tutti i rivestimenti sono fissi.
- Schienali dotati di meccanismo a snodo che si ripiega verso l'interno.
- Piedi in materiale termoplastico nero.
- Le cuciture per il rivestimento in pelle sono realizzate nel seguente modo:
Cucitura Cod.01 su cuscino di seduta, scocca braccio e parte centrale spalliera.
Cucitura Cod.03 per parte perimetrale spalliera.
- Il rivestimento in tessuto non possiede cuciture.
- Inserimento letto non possibile.
- Lato componibile rifinito.

Caratteristiche optional su richiesta senza maggiorazione

- Disponibile con cucitura a contrasto, per la scelta del colore fare riferimento ai codici del campionario pelli.

Caratteristiche optional su richiesta con maggiorazione

- Per il multi rivestimento il prezzo va incrementato del 7%, ad eccezione di quanto riportato nel paragrafo "senza maggiorazione". Per maggiori dettagli fare riferimento al paragrafo "NOTE" posto nelle prime pagine del listino.

Note

- I disegni grafici che riportano l'asterisco (*) sono sempre con lato rifinito e anche agganciabili agli elementi componibili.
- Non è possibile applicare altre cuciture.

Standard features

- Frame: wooden structure and solid fir wood with metal reinforcements, seat suspensions in reinforced elastic webbing.
- Paddings in eco-friendly open cell polyurethane foam, with different densities.
- Covering in leather or fabric. Not removable coverings.
- Backrests equipped with junction mechanism that folds inwards.
- Legs in black thermoplastic material.
- Stitchings only for the leather covering are being placed as per the following:
Stitching type Cod.01 for seat cushion, armrest frame and central part of backrest;
Stitching type Cod.03 for backrest perimetral part.
- No stitchings for fabric covering.
- No bed version available.
- Sectional sides finished.

Optional features available upon request without any upcharge

- Stitching, unless differently requested, will be matching the leather or fabric color. Contrast stitching color can be ordered at no extra charge. You might use as reference any Nicoline leather.

Optional features available upon request with an upcharge

- 7% upcharge for combined coverings, except as indicated in the paragraph "without any upcharge". Please refer to the notes at the beginning of pricelist.

Notes

- Versions with asterisk (*) have always the terminal side finished with the possibility to be connected to modular elements.
- Different stitchings not available.



I cuscini di schienale sono dotati di meccanismo //
Back cushion with mechanism on all elements

Cuciture //
Stitching

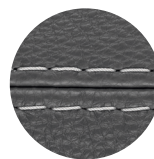

Cod.01

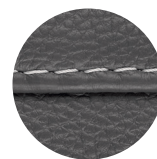

Cod.03

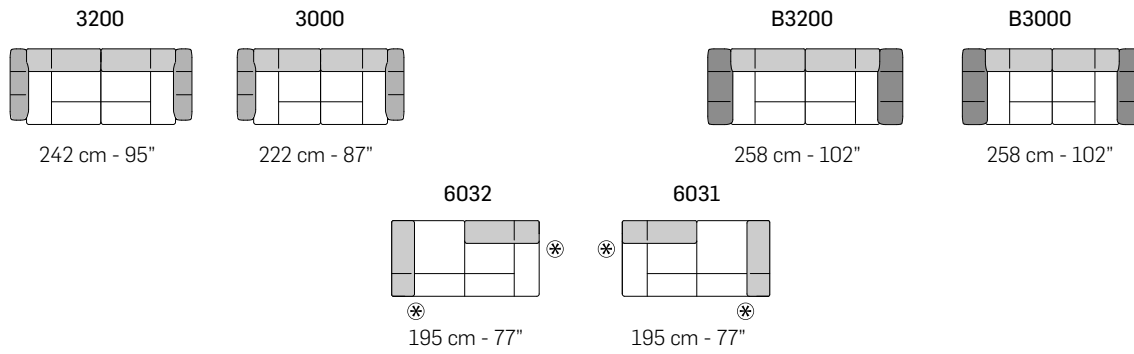

A

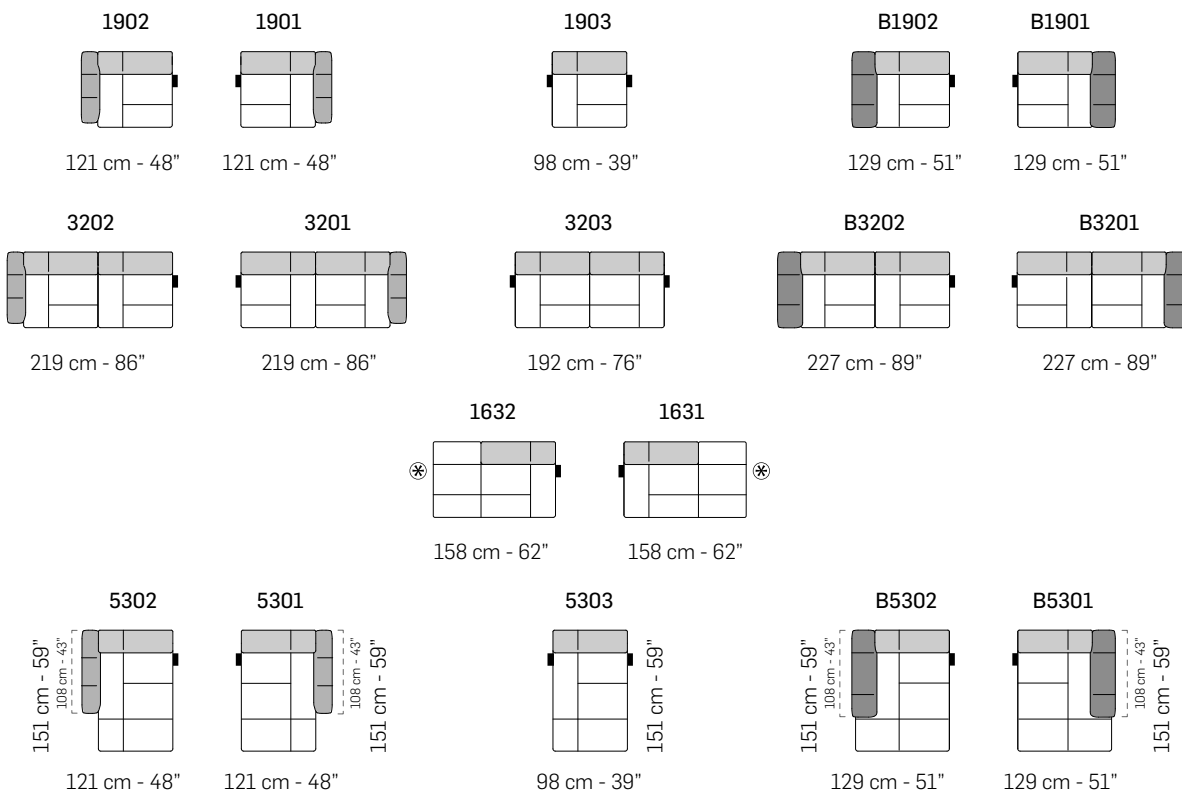

tutti gli elementi del gruppo A hanno lo stesso modulo di seduta - all items in group A have the same seat width

B

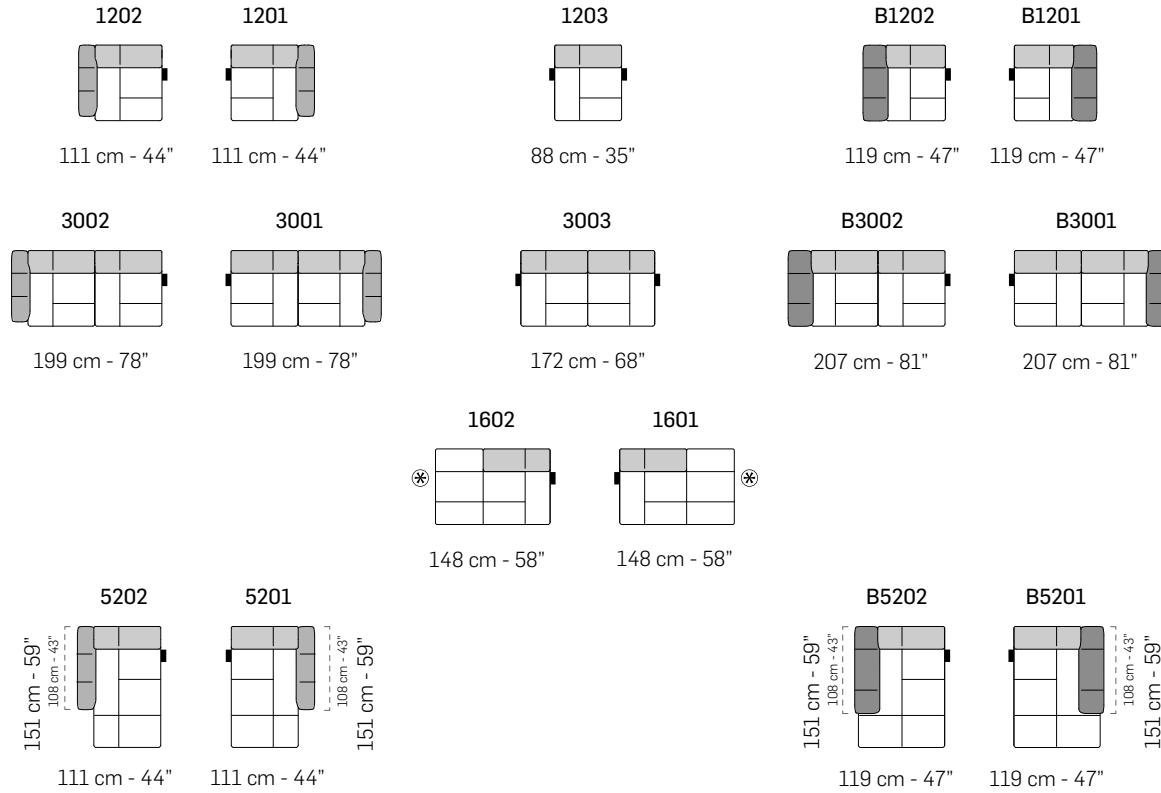

tutti gli elementi del gruppo B hanno lo stesso modulo di seduta - all items in group B have the same seat width

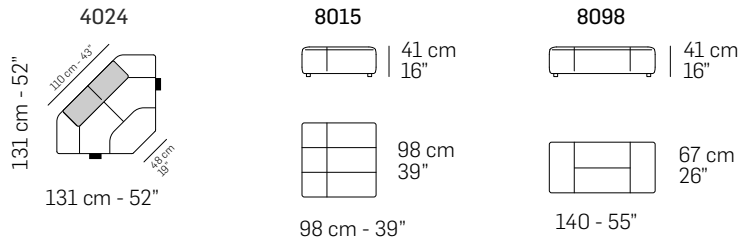

CUSCINETTI CONSIGLIATI / SUGGESTED PILLOWS

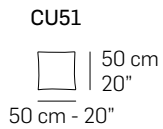

COMPOSIZIONI CONSIGLIATE / SUGGESTED COMPOSITIONS

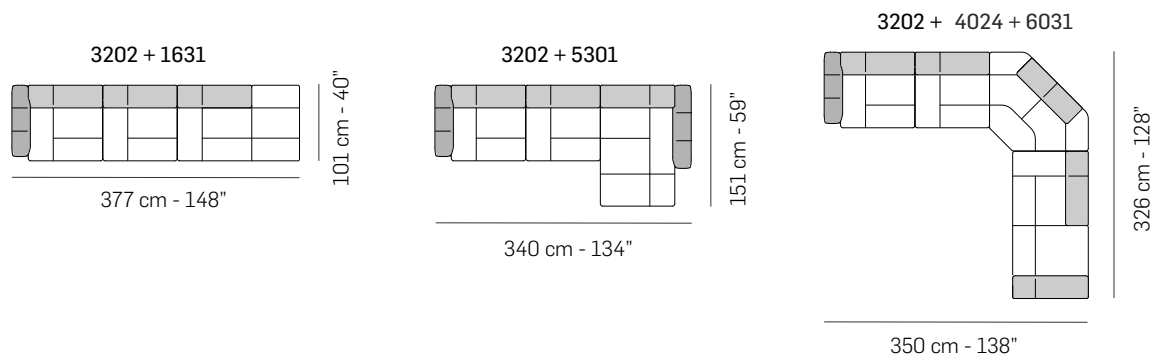

Scala 1:100
Ratio 1 to 100

Legenda / Legend

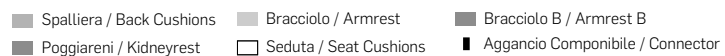

⊗ Lato terminale sempre rifinito e agganciabile agli elementi componibili / Terminal side is always finished and it can also be connected to modular elements

Note / Notes

Nicoline si riserva il diritto di apportare in ogni momento modifiche tecniche ed estetiche / Nicoline reserves the right to change, at any time and without prior warning, technical and aesthetic specifications of the articles.